

perixx

PERIDUO-606

Wireless 3-in-1 Combo with Ergonomic Mini Keyboard, Vertical Mouse and Numeric Keypad



▶User Manual ▶Bedienungsanleitung ▶Manual de instrucciones
▶Mode D'Emploi ▶Manuale Utente ▶マニュアル ▶产品说明书 ▶使用手册

VALUE
CREATOR

Product Illustration

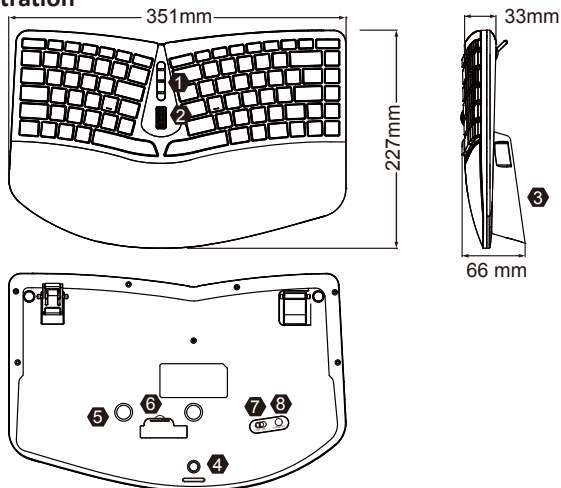

- ❶ LED Indicators (Low battery/Pairing/Number Lock, Caps Lock and Scroll Lock)
- ❷ Scroll Wheel/Middle Click ❸ Keyboard Stand
- ❹ Position 1: For Removable Magnet Foot & Keyboard Stand
- ❺ Position 2: For Removable Magnet Foot
- ❻ Battery & Receiver Storage ❼ On/Off switch ❽ Connect Button

Keyboard Indicators

Low Battery Indicator (LED flashing for 5 seconds)	Pairing (LED flashing for 10 seconds)	Number Lock on	Caps Lock on	Scroll Lock on

Product Illustration

③ Keyboard Stand

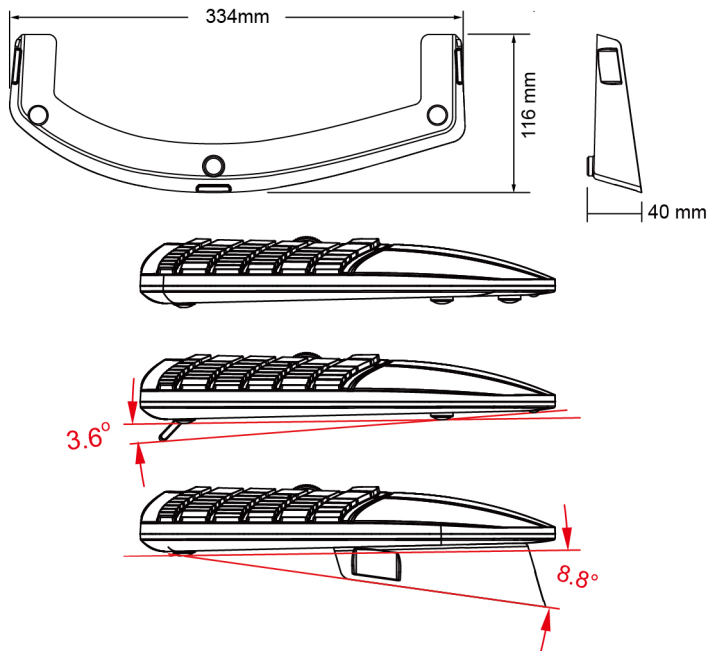

Product Illustration

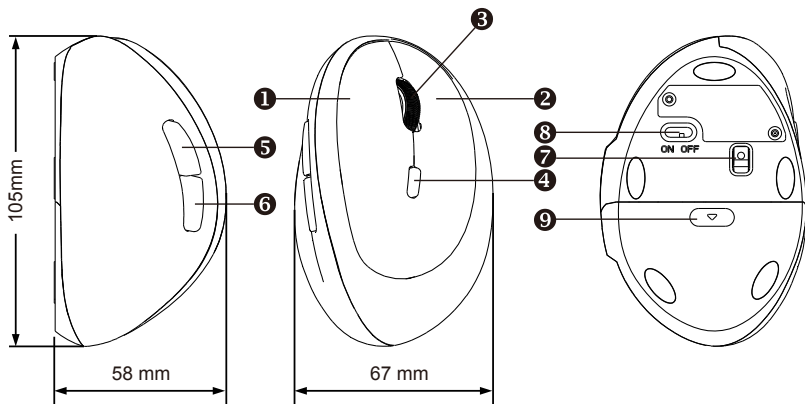

- ① Left Click Button(Primary Button)
- ② Right Click Button(Secondary Button)
- ③ Scroll Wheel/Middle Click
- ④ DPI Switch
3DPI Levels: 800/1200/1600 DPI

- ⑤ Forward Button
- ⑥ Backward Button
- ⑦ Sensor
- ⑧ On/Off Switch
- ⑨ Battery & Receiver Storage

Product Illustration

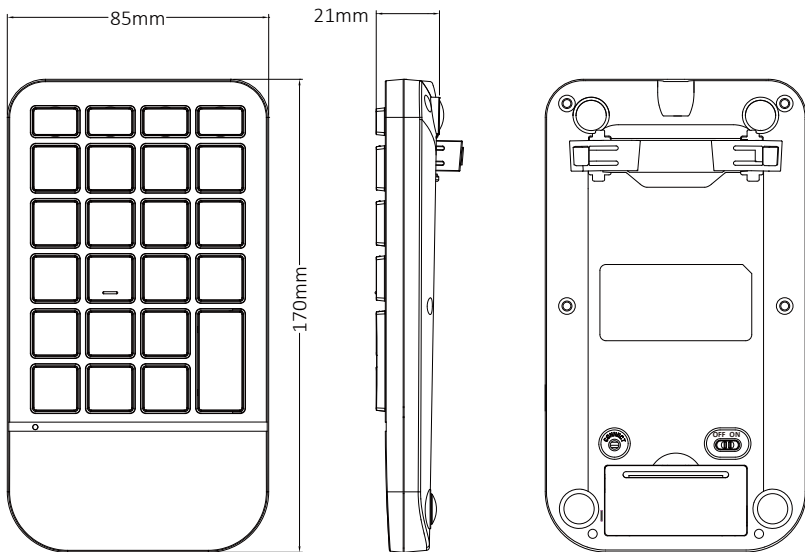

Low Battery (LED keeps flashing)



Number Lock on

How do you connect PERIDUO-606A?

1

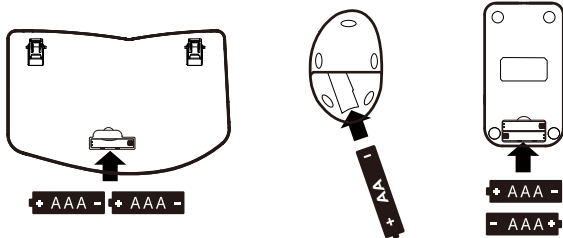

2

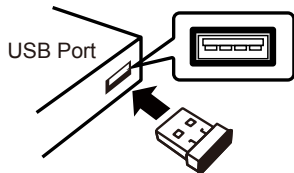

3

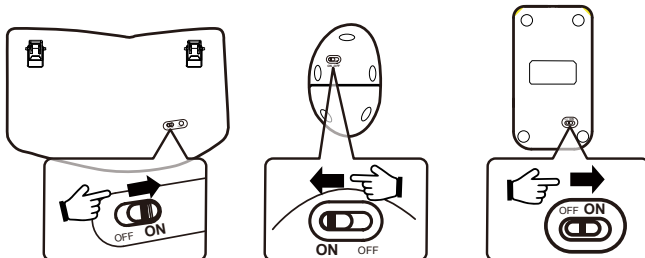

English(US/UK)

FCC Warning

This device complies with Part 15 of the FCC Rules. Operation is subject to the following two conditions:

(1) This device may not cause harmful interference, and (2) this device must accept any interference received, including interference that may cause undesired operation.

NOTE 1:

This equipment has been tested and found to comply with the limits for a Class B digital device, pursuant to part 15 of the FCC Rules. These limits are designed to provide reasonable protection against harmful interference in a residential installation. This equipment generates uses and can radiate radio frequency energy and, if not installed and used in accordance with the instructions, may cause harmful interference to radio communications. However, there is no guarantee that interference will not occur in a particular installation. If this equipment does cause harmful interference to radio or television reception, which can be determined by turning the equipment off and on, the user is encouraged to try to correct the interference by one or more of the following measures:

- Reorient or relocate the receiving antenna.
- Increase the separation between the equipment and receiver.
- Connect the equipment into an outlet on a circuit different from that to which the receiver is connected.
- Consult the dealer or an experienced radio/TV technician for help.

NOTE 2:

Any changes or modifications to this unit not expressly approved by the party responsible for compliance could void the user's authority to operate the equipment.

CE Caution

hereby declares that this Product is in compliance with the essential requirements and other relevant provisions of Directive 2014/53/EU.

The full text of the EU declaration of conformity is available at the internet address:
<https://perixx.com/pages/download-user-manual>

This product is intended for sale and application in a business environment.

RED Article 10 2

-This product can be used across EU member states

RED Article 10 10

-The product is class 1 product, No restrictions

Ensure that the product has undergone SAR testing at the appropriate distance and complies with the requirements of EN 62479:2010.

Frequency Range:
2408-2474MHz

English(US/UK)

Caution

- The manufacturer and re-resellers are not responsible for any technical malfunctions, damage, or personal injury incurred by:
 - Any attempt to dismantle, change or modify the product in any manner
 - Malfunction or damage is due to misuse or improper alteration or repair.
 - Malfunction or damage caused by external influence such as falling
 - Malfunction or damage is caused by fire, salt, gas, earthquake, lightning, wind, water, or other natural calamities, or abnormal voltage.
 - Malfunction or damage is caused by other devices connected to the products.
 - Malfunction or damage is caused by high temperature, humid, greasy, dusty, and hazardous environment.
- You are cautioned that changes or modifications not expressly approved by Perixx Computer GmbH could void your authority to operate the equipment.
- All brand names, trademarks, and logos are the properties of their respective owners.

Please Note: Long-term repetitive use of any keyboard and mouse could cause injury to the user. Perixx recommends users avoid excessive use of this or any keyboard and mouse.

Important Safety Instructions:

- Avoid dropping.
- Do not disassemble.
- This product is suitable for moderate climates only.
- The maximum ambient temperature during use of this product must not exceed 40 degree
- Open flame sources, such as candles, must not be placed on this product.
- Only use a dry cloth or brush to clean this product.

Perixx offers a one-year limited warranty with an optional one-year extension.

English(US/UK)

Specification

*Keyboard

Interface	2.4GHz	Number of keys	86 keys (US layout)
Size	351*227*66mm		87 keys (EU layout)
Weight	557g	Type of keyboard	Membrane
Input current	DC 3V 5mA	Actuation distance	2.2±0.2mm
Battery required	AAA batteries 2pcs	Total travel distance	4.5±0.2mm
Material	ABS	Durability	10 million keypresses
Operating system requirements	Win 7 or later		











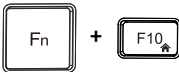

*Mouse

Interface	2.4GHz	Number of buttons	6
Size	105*58*67mm	DPI	800/1200/1600
Weight	107g±10g	Acceleration	10 G
Input current	DC 1.5V 9.5mA	Tracking speed	30 IPS
Battery required	AA battery 1pc	Report rate	125 Hz
Material	ABS	Durability	1 million keypresses
Operating system requirements	Win 7 or later		

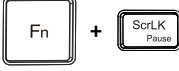
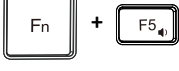
*Keypad

Interface	2.4GHz	Number of keys	23 keys
Size	156*86*20mm	Type of keyboard	Membrane
Weight	135g±10g	Actuation distance	1.3mm
Input current	DC 3V 10mA	Total travel distance	2.2±0.2mm
Battery required	AAA batteries 2pcs	Durability	10 million keypresses
Material	ABS		
Operating system requirements	Win 7 or later		

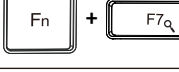
Multimedia keys

	Previous Track		E-mail
	Play/Pause		Home
	Next Track		Calculator
	Mute		Pause
	Volume down		Insert
	Volume up		Scroll Lock
	Search		Delete
	My favorite		

Deutsch (DE)

Bitte beachten Sie:

- Der Hersteller sowie die Wiederverkäufer sind nicht verantwortlich für technische Defekte, Schäden oder mögliche Verletzungen verursacht durch:
 - Versuche, den Artikel zu demontieren oder in jeglicher Form zu verändern
 - Zweckentfremdung oder eigene Reparaturen
 - Fremdeinwirkung wie z.B. Sturz oder Schlag
 - Feuer, Gas, Erdbeben, Blitz, Wind, Wasser, Überspannung oder jede andere Form von äußerer Gewalt
 - Andere mit der Tastatur verbundene Geräte
 - Zu hohe Temperaturen oder eine feuchte, staubige oder gefährliche Umgebung
- Der Benutzer wird darauf hingewiesen, dass Änderungen oder Modifizierungen an den Geräten, die von Perixx Computer GmbH nicht ausdrücklich genehmigt sind, die Erlaubnis des Benutzers zur Inbetriebnahme des Gerätes außer Kraft setzen könnte.
- Alle Markennamen, Warenzeichen und Logos sind Eigentum Perixx.

Die übermäßige Langzeit-Verwendung jeder Tastatur und Maus kann zu Verletzungen führen. Perixx empfiehlt Benutzern den übermäßigen Gebrauch von jeglicher Tastatur und Maus zu vermeiden.

Wichtige Sicherheitsanweisungen

- Lassen Sie das Gerät nicht fallen
- Bauen Sie das Gerät nicht auseinander
- Das Gerät ist für moderates Klima zur privaten Benutzung konzipiert
- Die maximale Umgebungstemperatur während der Verwendung dieses Produktes darf 40 Grad nicht überschreiten
- Offene Flammenquellen wie Kerzen dürfen nicht auf dieses Produkt gestellt werden.
- Verwenden Sie zur Reinigung dieses Produkts nur ein trockenes Tuch oder eine weiche Bürste.

Perixx bietet 1 Jahr beschränkte Garantie, ein weiteres Jahr kann optional verlängert werden. Dies beeinträchtigt nicht die gesetzliche Gewährleistung.

Deutsch (DE)

Technische Daten

*Tastatur

Schnittstelle	2.4GHz	Tastenanzahl	86 Tasten (US Layout)
Abmessungen	351*227*66mm		87 Tasten (EU Layout)
Gewicht	557g	Tastentyp	Membran
Eingangsstrom	DC 3V 5mA	Tastendrucksignal	2.2±0.2mm
Benötigte Batterien	2 x AAA Batterie	Gesamter Tastenhub	4.5±0.2mm
Material	ABS	Lebensdauer	10 Millionen Tastenanschläge
Betriebssystem	Win 7 oder höher		















*Maus

Schnittstelle	2.4GHz	Tastenanzahl	6
Abmessungen	105*58*67mm	Auflösung (DPI)	800/1200/1600
Gewicht	107g±10g	Maximale Beschleunigung	10 G
Eingangsstrom	DC 1.5V 9.5mA	Maximale Geschwindigkeit	30 IPS
Benötigte Batterien	1 x AA Batterie	USB-Signalrate	125 Hz
Material	ABS	Lebensdauer	1 Millionen Tastenanschläge
Betriebssystem	Win 7 oder höher		

*Nummernblock

Schnittstelle	2.4GHz	Tastenanzahl	23 Tasten
Abmessungen	156*86*20mm	Tastentyp	Membran
Gewicht	135g±10g	Tastendrucksignal	1.3mm
Eingangsstrom	DC 3V 10mA	Gesamter Tastenhub	2.2±0.2mm
Benötigte Batterien	2 x AAA Batterie	Lebensdauer	10 Millionen Tastenanschläge
Material	ABS		
Betriebssystem	Win 7 oder höher		

Multimedia-Tasten

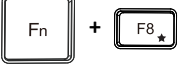
	Vorheriges Lied		E-Mail öffnen
	Abspielen/Pause		Startseite
	Nächstes Lied		Rechner
	Stumm		Pause/Untbr
	Lautstärke verringern		Entf
	Lautstärke erhöhen		Rollen ↓
	Suchen		Entf
	Favoriten		

ESPAÑOL (ES)

Tenga en cuenta:

- El fabricante y los distribuidores no son responsables de los defectos técnicos, daño o perjuicio causado por:
 - ▶ intentos de desmantelar o cambiar el producto en cualquier forma
 - ▶ apropiación indebida o reparaciones realizadas por el usuario
 - ▶ acontecimientos externos como caídas o golpes
 - ▶ fuego, gas, terremotos, rayos, viento, agua o cualquier otro acontecimiento externo
 - ▶ otros dispositivos conectados al teclado
 - ▶ temperaturas altas o un ambiente húmedo, polvoriento o peligroso
- Se advierte al usuario que los cambios o modificaciones del producto que no estén aprobados expresamente por Perixx Computer GmbH, permiten anular el uso del dispositivo al usuario.
- Todos los nombres de marcas, marcas comerciales y logotipos son propiedad de Perixx.

El uso excesivo a largo plazo de cualquier teclado y el ratón puede causar lesiones. Perixx recomienda evitar el uso excesivo de cualquier teclado y ratón.

Indicaciones importantes de seguridad

- Evite las caídas.
- No desmonte el producto.
- Este producto es apto solo en climas moderados.
- La temperatura ambiente máxima durante el uso del producto no debe superar los 40 grados.
- No exponer el producto a fuentes de llama, como velas.
- Solo utilice un paño o cepillo seco para limpiar el producto.

Perixx ofrece una **garantía limitada de un año** y la posibilidad de prolongarla por un año adicional

Español (ES)

Características

*Teclado

Interfaz	2.4GHz	Numero de teclas	86 teclas (Configuración US)
Tamaño	351*227*66mm		87 teclas (Configuración EU)
Peso	557g	Tipo de tecla	Membrana
Corriente de entrada	DC 3V 5mA	Distancia de actuación	2.2±0.2mm
Requiere batería	2 unidades de batería tipo AAA	Recorrido total	4.5±0.2mm
Material	ABS	Duración	10 millones de pulsaciones
Sistema operativo requerido	Win 7 o posterior		









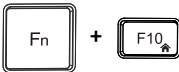

*Ratón

Interfaz	2.4GHz	Numero de botones	6
Tamaño	105*58*67mm	Resolución (DPI)	800/1200/1600
Peso	107g±10g	Aceleración máx.	10 G
Corriente de entrada	DC 1.5V 9.5mA	Velocidad máx.	30 IPS
Requiere batería	1 unidad de batería tipo AA	Velocidad de respuesta	125 Hz
Material	ABS	Duración	1 millón de pulsaciones
Sistema operativo requerido	Win 7 o posterior		

*Teclado Numérico

Interfaz	2.4GHz	Numero de teclas	23 teclas
Tamaño	156*86*20mm	Tipo de tecla	Membrana
Peso	135g±10g	Distancia de actuación	1.3mm
Corriente de entrada	DC 3V 10mA	Recorrido total	2.2±0.2mm
Requiere batería	2 unidades de batería tipo AAA	Duración	10 millones de pulsaciones
Material	ABS		
Sistema operativo requerido	Win 7 o posterior		

Teclas Multimedia

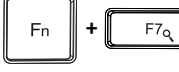
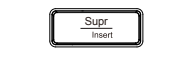
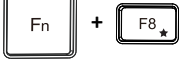
	Canción anterior		Abrir Correo
	Reproducir / Pausa		Página de Inicio
	Canción siguiente		Calculador
	Silencioso		Pausa
	Disminuir volumen		Insert
	Aumentar volumen		Bloq Despl
	Búsqueda		Supr
	Favoritos		

FRANÇAIS (FR)

Avertissement

- Le fabricant et les revendeurs ne sont pas responsables des défaillances techniques, des dommages ou des blessures occasionnées par:
 - Toute tentative de démonter, changer ou modifier le produit de quelques manières
 - Dysfonctionnements ou dommages à cause d'une mauvaise utilisation, modification incorrecte ou réparation.
 - Dysfonctionnements ou dommages causés par la chute après l'achat.
 - Dysfonctionnements ou dommages causés par : un incendie, le sel, le gaz, un tremblement de terre, la foudre, le vent, l'eau, ou d'autres catastrophes naturelles, ou d'une pression anormale.
 - Dysfonctionnements ou dommages causés par d'autres appareils connectés au clavier.
 - Dysfonctionnements ou dommages causés par une température élevée, un environnement humide, gras, poussiéreux ou dangereux
- Vous êtes averti que des changements ou des modifications ne sont pas expressément approuvés par le responsable tiers pour la conformité pourraient annuler votre autorité quant à utiliser cet appareil.
- Tous les noms de marque, marques et logos sont la propriété de leurs propriétaires respectifs.

S'il vous plaît noter: L'utilisation répétitive à long terme d'un clavier et une souris pourrait causer des blessures à l'utilisateur. Perixx recommande aux utilisateurs d'éviter l'utilisation excessive de clavier et de souris.

Instructions importantes de sécurité

- Ne pas faire tomber.
- Ne pas démonter.
- Ce produit est adapté uniquement aux climats modérés.
- La température ambiante maximale pendant l'utilisation de ce produit ne doit pas dépasser 40 degrés.
- Ce produit ne doit pas être exposé à des sources de flamme, notamment des bougies.
- Nettoyez ce produit uniquement avec un chiffon sec ou une brosse.

Perixx offre une garantie limitée d'un an avec une extension optionnelle d'un an.

Français (FR)

Spécifications techniques

*Clavier

Interface	2.4GHz	Nombre de touches	86 touches (Disposition US)
Taille	351*227*66mm		87 touches (Disposition Européenne)
Poids	557g	Type de touches	Membrane
Courant d'entrée	DC 3V 5mA	Distance d'activation	2.2±0.2mm
Pile requise	Piles AAA 2pcs	Distance de course totale	4.5±0.2mm
Matériel	ABS	Durabilité	10 millions de frappes
Exigence du système d'exploitation	Win 7 ou version ultérieure		











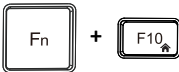

*Souris

Interface	2.4GHz	Nombre de boutons	6
Taille	105*58*67mm	Résolution (DPI)	800/1200/1600
Poids	107g±10g	Accélération max.	10 G
Courant d'entrée	DC 1.5V 9.5mA	Vitesse max.	30 IPS
Pile requise	Pile AA 1pcs	Taux de rapports	125 Hz
Matériel	ABS	Durabilité	1 millions de frappes
Exigence du système d'exploitation	Win 7 ou version ultérieure		

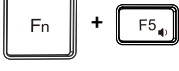
*Pavé numérique

Interface	2.4GHz	Nombre de touches	23 touches
Taille	156*86*20mm	Type de touches	Membrane
Poids	135g±10g	Distance d'activation	1.3mm
Courant d'entrée	DC 3V 10mA	Distance de course totale	2.2±0.2mm
Pile requise	Piles AAA 2pcs	Durabilité	10 millions de frappes
Matériel	ABS		
Exigence du système d'exploitation	Win 7 ou version ultérieure		

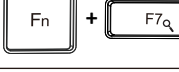
Touches Multimédia

	Morceau précédent		Ouvrir E-Mail
	Lecture / Pause		Page d'accueil
	Morceau Suivant		Calculatrice
	Silencieux		Pause
	Diminuer le Volume		Inser
	Augmenter le Volume		Arrêt défil
	Recherche		Suppr
	Favoris		

ITALIANO (IT)

Attenzione

- Il produttore e i rivenditori non sono responsabili per eventuali malfunzionamenti tecnici, danni o lesioni personali causati da:
 - Qualsiasi tentativo di smantellare, cambiare o modificare il prodotto in qualsiasi modo
 - Malfunzionamenti o danni dovuti ad uso, alterazione o riparazione impropri.
 - Malfunzionamenti o danni causati da fattori esterni come la caduta
 - Malfunzionamenti o danni causati da incendi, sale, gas, terremoti, fulmini, vento, acqua, o altre calamità naturali, ovvero da voltaggio anomalo.
 - Malfunzionamenti o danni causati da altri dispositivi connessi al prodotto.
 - Malfunzionamenti o danni causati da alte temperature ovvero da ambiente umido, grasso, polveroso o pericoloso.
- Si avvisa che alterazioni o modifiche non espressamente approvate da Perixx Computer GmbH potrebbero annullare il vostro permesso di utilizzare l'apparecchiatura.
- Tutte le etichette, i marchi e loghi sono di proprietà dei rispettivi titolari.

Nota: A lungo termine l'uso ripetitivo di qualsiasi tastiera e mouse potrebbe causare lesioni all'utente. Perixx consiglia agli utenti di evitare l'uso eccessivo di questa o di qualsiasi altra tastiera o mouse.

Istruzioni importanti per la sicurezza

- Evita cadute
- Non smontare
- Questo prodotto è adatto solo per climi temperati
- La temperatura di ambiente durante l'uso di questo prodotto non deve superare i 40 gradi
- Fonti di fiamme libere, come candele, non devono essere posizionate su questo prodotto.
- Utilizzare solo un panno asciutto o una spazzola per pulire questo prodotto.

Perixx offre una garanzia limitata di un anno con un'estensione opzionale di un anno.

ITALIANO (IT)

Specifiche

*Tastiera

Interfaccia	2.4GHz	Numero di tasti	86 tasti (Layout US)
Dimensioni	351*227*66mm		87 tasti (Layout EU)
Peso	557g	Tipo di tastiera	A membrana
Corrente in entrata	DC 3V 5mA	Raggio di azione	2.2±0.2mm
Batterie Necessarie	2 batterie AAA	Corsa totale	4.5±0.2mm
Materiale	ABS	Durata	10 milioni di pressioni sui tasti
Requisiti del sistema operativo	Win 7 o versioni successive		









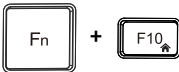

*Mouse

Interfaccia	2.4GHz	Numero di pulsanti	6
Dimensioni	105*58*67mm	Risoluzione (DPI)	800/1200/1600
Peso	107g±10g	Accelerazione massima	10 G
Corrente in entrata	DC 1.5V 9.5mA	Velocità massima	30 IPS
Batterie Necessarie	1 batteria AA	Frequenza di aggiornamento	125 Hz
Materiale	ABS	Durata	1 milione di pressioni sui tasti
Requisiti del sistema operativo	Win 7 o versioni successive		

*Tastierino numerico

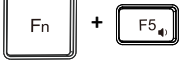
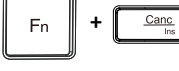
Interfaccia	2.4GHz	Numero di tasti	23 tasti
Dimensioni	156*86*20mm	Tipo di tastiera	A membrana
Peso	135g±10g	Raggio di azione	1.3mm
Corrente in entrata	DC 3V 10mA	Corsa totale	2.2±0.2mm
Batterie Necessarie	2 batterie AAA	Durata	10 milioni di pressioni sui tasti
Materiale	ABS		
Requisiti del sistema operativo	Win 7 o versioni successive		

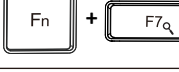
Tasti Multimediali

	Traccia precedente		E-Mail
	Play/Pausa		Pagina Iniziale
	Traccia successiva		Calcolatrice
	Silenzioso		Pausa
	Abbassare il volume		Ins
	Alzare il volume		Bloc Scorr
	Ricerca		Canc
	Favoriti		

日本語 (JA)

保証規定のご注意

- 保証期間中でも次の場合は、弊社若しくは再販売業者が保証対象外と判断させていただきます。
 - ▶ 弊社および弊社が指定する機関以外の第三者ならびにお客様による改造、分解、修理により故障した場合。
 - ▶ 乱用、誤用などによる故障・損傷が生じた場合。
 - ▶ お取扱上の不注意（落下、衝撃、水掛り、砂・泥の付着、機器内部への水・砂・薬品の入り込みなど）により故障した場合。
 - ▶ 地震、火災、落雷、風水害、その他の天変地異、公害、異常電圧などの外的要因により故障した場合。
 - ▶ 弊社が定める機器以外に接続、または組み込んで使用し、故障または破損した場合。
 - ▶ 通常一般家庭内で想定される使用環境の範囲を超える温度、湿度、振動等、若しくは手入れの不備（カビ発生、チリ・ホコリ等）により故障した場合。
 - ▶ その他、無償修理または交換が認められない事由が発見された場合。
- 利用規約を遵守いただけない場合(不当な改造や修理等)には、本製品の使用を制限させていただく場合がございます。何卒ご了承ください。
- 本書に記載のブランド名、ロゴマーク商標権はPerixxが所有しています。

ご注意:マウスやキーボードなどを長時間操作すると、手や腕や首、肩などに深刻な障害を引き起こす恐れがあります。長時間連続でご使用する際は、十分に休憩を取りながらご使用ください。

安全にお使いいただくために

- 落とさないでください。
- 分解しないでください。
- 極度に暑い・寒い環境での使用はお避け下さい。
- 使用時の最高気温は40度です。
- ろうそくなどの火を製品に近づけないでください。
- 掃除の際は乾いた布またはブラシをご使用ください。

ペリックスでは、製品保証を購入日より1年間提供しています。

日本語 (JA)

製品の仕様

*キーボード

インターフェイス	2.4GHz	キーの数	86 キー (英語配列)
サイズ	351*227*66mm		87 キー (EU配列)
重さ	557g	キースイッチ	メンブレン
入力電流	DC 3V 5mA	キーストローク (接点)	2.2±0.2mm
必要電池	単四電池 2個	キーストローク	4.5±0.2mm
材質	ABS	打鍵耐久性	1000万回の打鍵
対応システム	Win 7以降		











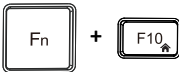

*マウス

インターフェイス	2.4GHz	ボタンの数	6
サイズ	105*58*67mm	DPI (カーソル移動速度)	800/1200/1600
重さ	107g±10g	最大加速	10 G
入力電流	DC 1.5V 9.5mA	最大速度	30 IPS
必要電池	単三電池 1個	USBレポートレート	125 Hz
材質	ABS	耐久性	100万回の打鍵
対応システム	Win 7以降		

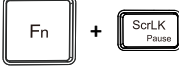
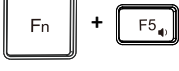
*キーパッド

インターフェイス	2.4GHz	キーの数	23 キー
サイズ	156*86*20mm	キースイッチ	メンブレン
重さ	135g±10g	キーストローク (接点)	1.3mm
入力電流	DC 3V 10mA	キーストローク	2.2±0.2mm
必要電池	単四電池 2個	打鍵耐久性	1000万回の打鍵
材質	ABS		
対応システム	Win 7以降		

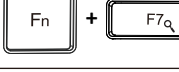
マルチメディアキー

	前の曲		メール
	再生/一時停止		ホームページ
	次の曲		電卓
	ミュート		Pause
	音量を下げる		Insert
	音量を上げる		Scroll Lock
	検索		Delete
	お気に入り		

简体中文 (SC)

注意

- 制造商和经销商不对以下行为所导致的任何技术故障损失或人身伤害承担责任：
 - 以任何方式试图拆除、更改或修改产品引起的故障或损坏；
 - 由于使用不当或更改、修理引起的故障或损坏；
 - 由于摔落等外因引起的故障或损坏；
 - 由于火灾、化学品、气体、地震、雷电、风灾、水灾等自然灾害或异常电压引起的故障或损坏；
 - 由于与本产品连接的其它设备引起的故障或损坏；
 - 由于高温、潮湿、油腻、多尘和危险环境引起的故障或损坏。
- 未经我公司明确批准的变更或修理可能使用户失去对设备的操作权限。
- 相关品牌名称、商标和标识均为我公司财产。

请注意：长时间使用键盘和鼠标可能对用户造成伤害。佩锐建议用户避免过度使用任何键盘和鼠标类产品。

重要安全说明

- 避免跌落。
- 请勿拆卸。
- 本产品仅适用于温和气候。
- 本产品使用期间的最高环境温度不得超过40摄氏度。
- 不得在本产品上放置开放式火源，如蜡烛。
- 只能用干布或刷子清洁本产品。

佩锐为您提供一年保修服务。

简体中文 (SC)

规格

*键盘

接口	2.4GHz	按键数	86 键 (美式按键布局) 87 键 (欧洲按键布局)
尺寸	351*227*66mm	键型	薄膜
重量	557g	触发键程	2.2±0.2mm
工作电压电流	DC 3V 5mA	总行程距离	4.5±0.2mm
电池需求	2个7号电池	按键寿命	1000万次
材料	ABS塑料		
操作系统要求	Win 7或更高版本		











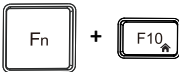

*鼠标

接口	2.4GHz	按键数	6
尺寸	105*58*67mm	解析度 (DPI)	800/1200/1600
重量	107g±10g	最大加速度	10 G
工作电压电流	DC 1.5V 9.5mA	最大速度	30 IPS
电池需求	1个5号电池	回报率	125 Hz
材料	ABS塑料	按键寿命	100万次
操作系统要求	Win 7或更高版本		

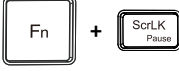
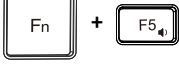
*数字键盘

接口	2.4GHz	按键数	23 键
尺寸	156*86*20mm	键型	薄膜
重量	135g±10g	触发键程	1.3mm
工作电压电流	DC 3V 10mA	总行程距离	2.2±0.2mm
电池需求	2个7号电池	按键寿命	1000万次
材料	ABS塑料		
操作系统要求	Win 7或更高版本		

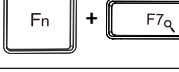
多媒体功能键

	上一曲		邮件
	播放/暂停		主页
	下一曲		计算器
	静音		Pause
	降低音量		Insert
	提高音量		Scroll Lock
	查找		Delete
	我的最爱		

繁體中文 (TC)

注意

- 製造商和經銷商不對以下行為所導致的任何技術故障損失或人身傷害承擔責任
 - ▶ 以任何方式企圖拆除、更改或修改產品引起的故障或損壞
 - ▶ 由於誤用或不當更改，修理故障引起的故障或損壞
 - ▶ 購買後摔落產品引起的故障或損壞
 - ▶ 由於鹽、氣體、地震、曝曬、風、水及其他自然災害，或異常電壓引起的故障或損壞
 - ▶ 由於產品連接到其它設備引起的故障或損壞。
 - ▶ 由於高溫、潮濕、油膩、多塵和危險的環境引起的故障或損壞
- 請注意，未經我司明確批准的變更或修改，可能使使用者失去對設備的操作許可權
- 所有的品牌名稱、商標和標誌均為我司財產

取得審驗證明之低功率射頻器材，非經核准，公司、商號或使用者均不得擅自變更頻率、加大功率或變更原設計之特性及功能。低功率射頻器材之使用不得影響飛航安全及干擾合法通信；經發現有干擾現象時，應立即停用，並改善至無干擾時方得繼續使用。前述合法通信，指依電信管理法規定作業之無線電通信。低功率射頻器材須忍受合法通信或工業、科學及醫療用電波輻射性電機設備之干擾。

請注意：長期反覆使用鍵盤和滑鼠可能對用戶造成傷害，佩銳建議消費者避免過度使用任何鍵盤和滑鼠產品。

重要安全提醒

- . 避免掉落
- . 請勿拆解
- . 本產品僅能在溫和的氣候下使用
- . 使用本產品時，周圍環境溫度不能超過40度
- . 請勿將火源(如蠟燭) 放置在本產品上
- . 僅可使用乾布或刷子清潔本產品

佩銳為您提供一年保固服務

繁體中文 (TC)

規格

*鍵盤

介面	2.4GHz	按鍵數	86 鍵 (美式鍵盤配置)
尺寸	351*227*66mm		87 鍵 (歐式鍵盤配置)
重量	557g	按鍵類型	薄膜式
輸入電流	DC 3V 5mA	觸發鍵程	2.2±0.2mm
電池需求	AAA四號電池兩顆	總行程	4.5±0.2mm
材質	ABS塑膠	按鍵壽命	1000萬次
作業系統	Win 7或更新版本		









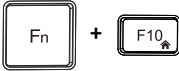

*滑鼠

介面	2.4GHz	按鍵數	6
尺寸	105*58*67mm	解析度(DPI)	800/1200/1600
重量	107g±10g	加速度	10 G
輸入電流	DC 1.5V 9.5mA	追蹤速度	30 IPS
電池需求	AA三號電池一顆	回報率	125 Hz
材質	ABS塑膠	按鍵壽命	100萬次
作業系統	Win 7或更新版本		

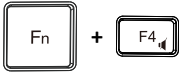
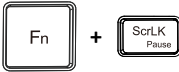
*數字鍵

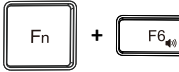
介面	2.4GHz	按鍵數	23 鍵
尺寸	156*86*20mm	按鍵類型	薄膜式
重量	135g±10g	觸發鍵程	1.3mm
輸入電流	DC 3V 10mA	總行程	2.2±0.2mm
電池需求	AAA四號電池兩顆	按鍵壽命	1000萬次
材質	ABS塑膠		
作業系統	Win 7或更新版本		

多媒體功能鍵

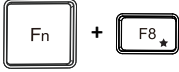
	上一首		E-mail
	播放/暫停		首頁
	下一首		計算機
	靜音		Pause
	調低音量		Insert
	調高音量		Scroll Lock
	搜尋		Delete
	我的最愛		

限用物質含有情況標示表

設備名稱：無線鍵盤 Equipment name	型號(型式): PERIDUO-606A Type designation (Type)					
單元 Unit	限用物質及其化學符號 Restricted substances and its chemical symbols					
	鉛Lead (Pb)	汞Mercury (Hg)	鎘Cadmium (Cd)	六價鉻 Hexavalent chromium Cr ⁺⁶	多溴聯苯 Polybrominated biphenyls (PBB)	多溴二苯醚 Polybrominated diphenyl ethers (PBDE)
鍵盤內外殼	○	○	○	○	○	○
鍵盤模組	○	○	○	○	○	○
電路板	○	○	○	○	○	○
電線	○	○	○	○	○	○
<p>備考 1. “超出0.1 wt %”及“超出0.01 wt %”係指限用物質之百分比含量超出百分比含量基準值。 Note 1: “Exceeding 0.1 wt %” and “exceeding 0.01 wt %” indicate that the percentage content of the restricted substance exceeds the reference percentage value of presence condition.</p> <p>備考 2. “○”係指該項限用物質之百分比含量未超出百分比含量基準值。 Note 2: “○” indicates that the percentage content of the restricted substance does not exceed the percentage of reference value of presence.</p> <p>備考 3. “-”係指該項限用物質為排除項目。 Note 3: The “-” indicates that the restricted substance corresponds to the exemption</p>						

無線鍵盤

型號：PERIDUO-606A

額定電壓：DC 3V \equiv 5mA

製造號碼：如本體

製造年份：2024

原產地：中國大陸



R3B701

RoHS

製造商：佩銳科技(深圳)有限公司

地址：深圳市南山區西麗街道新光路43號
聚創金谷創意園A棟#509-510

進口商：佩銳科技有限公司

地址：10052台北市中正區徐州路18巷32號1樓

電話：+886-2-2748-5232

限用物質含有情況標示表

設備名稱：無線數字鍵 Equipment name		型號(型式)：PERIDUO-606A Type designation (Type)				
單元 Unit	限用物質及其化學符號 Restricted substances and its chemical symbols					
	鉛Lead (Pb)	汞Mercury (Hg)	鎘Cadmium (Cd)	六價鉻Hexavalent chromium Cr ⁶⁺	多溴聯苯Polybrominated biphenyls (PBB)	多溴二苯醚Polybrominated diphenyl ethers (PBDE)
鍵盤內外殼	○	○	○	○	○	○
鍵盤模組	○	○	○	○	○	○
電路板	○	○	○	○	○	○
電線	○	○	○	○	○	○

備考 1. “超出0.1 wt %”及“超出0.01 wt %”係指限用物質之百分比含量超出百分比含量基準值。
Note 1: “Exceeding 0.1 wt %” and “exceeding 0.01 wt %” indicate that the percentage content of the restricted substance exceeds the reference percentage value of presence condition.

備考 2. “○”係指該項限用物質之百分比含量未超出百分比含量基準值。
Note 2: “○” indicates that the percentage content of the restricted substance does not exceed the percentage of reference value of presence.

備考 3. “-”係指該項限用物質為排除項目。
Note 3: The “-” indicates that the restricted substance corresponds to the exemption

無線數字鍵

型號：PERIDUO-606A

額定電壓：DC 3V \approx 10mA

製造號碼：如本體

製造年份：2024

原產地：中國大陸



R3B701
RoHS

限用物質含有情況標示表

設備名稱：無線滑鼠 Equipment name		型號(型式)：PERIDUO-606A Type designation (Type)				
單元 Unit	限用物質及其化學符號 Restricted substances and its chemical symbols					
	鉛Lead (Pb)	汞Mercury (Hg)	鎘Cadmium (Cd)	六價鉻Hexavalent chromium Cr ⁶⁺	多溴聯苯Polybrominated biphenyls (PBB)	多溴二苯醚Polybrominated diphenyl ethers (PBDE)
滑鼠滾輪	○	○	○	○	○	○
電路板(包含零組件)	○	○	○	○	○	○
滑鼠上下蓋	○	○	○	○	○	○
接收器的外型	○	○	○	○	○	○
滑鼠腳墊	○	○	○	○	○	○
滑鼠透視	○	○	○	○	○	○

備考 1. “超出0.1 wt %”及“超出0.01 wt %”係指限用物質之百分比含量超出百分比含量基準值。
Note 1: “Exceeding 0.1 wt %” and “exceeding 0.01 wt %” indicate that the percentage content of the restricted substance exceeds the reference percentage value of presence condition.

備考 2. “○”係指該項限用物質之百分比含量未超出百分比含量基準值。
Note 2: “○” indicates that the percentage content of the restricted substance does not exceed the percentage of reference value of presence.

備考 3. “-”係指該項限用物質為排除項目。
Note 3: The “-” indicates that the restricted substance corresponds to the exemption

無線滑鼠

型號：PERIDUO-606A

額定電壓：DC 1.5V \approx 9.5mA

製造號碼：如本體

製造年份：2024

原產地：中國大陸



R3B701
RoHS

製造商：佩銳科技(深圳)有限公司

地址：深圳市南山區西麗街道新光路43號

聚創金谷創意園A棟#509-510

進口商：佩銳科技有限公司

地址：10052台北市中正區徐州路18巷32號1樓

電話：+886-2-2748-5232



EU Declaration of Conformity

Manufacturer's Name: Perlxx Computer GmbH
Manufacturer's Address: Heerdter Landstrasse 189e,
40549 Düsseldorf, Germany

Declares that the product:

Product Name: Wireless 3-in-1 Combo with Ergonomic
Mini Keyboard, Vertical Mouse and Numeric Keypad

Model Name: PERIDUO-606A

**The object of the declaration described above is in conformity with the following
EU harmonisation legislations:**

RED 2014/53/EU Directive

and conforms to the following standards:

EN 50663 :2017
EN 62479 :2010
EN 62368-1 :2014+A11 :2017
ETSI EN 301 489-1 V2.2.3 (2019-11)
ETSI EN 301 489-3 V2.1.1 (2019-03)
ETSI EN 300 440 V2.2.1 (2018-07)

**This declaration of conformity is issued under the sole responsibility of the
manufacturer or representative.**

Perlxx Computer GmbH

Allen Liang
Technical Director

Perlxx Computer GmbH

Heerdter Landstrasse 189 e
40549 Düsseldorf
Germany

Tel.: +49 - 211 - 56 94 88 - 0
Fax: +49 - 211 - 56 94 88 22

petixx

VALUE
CREATOR